

# SHARP®

# LC-20M4U

ENGLISH

FRANÇAIS

**LCD AV MONITOR  
MONITEUR AV À CRISTAUX  
LIQUIDES**

**OPERATION MANUAL  
MODE D'EMPLOI**

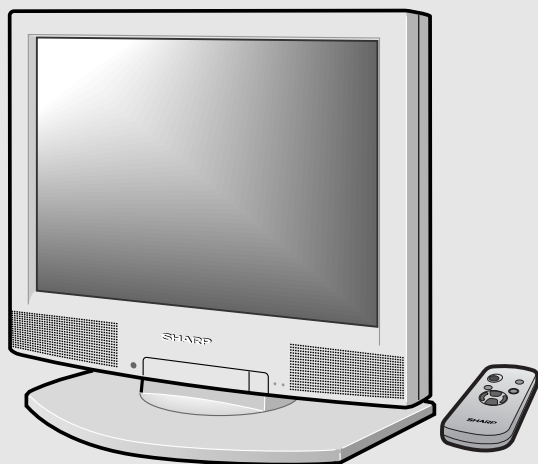

Printed on post-consumer recycled paper.  
Imprimé sur du papier recyclé.

Printed in Japan  
Imprimé au Japon  
TINS-7530CEZZ   
01P11-JKK

# LC-20M4U

LCD AV MONITOR

ENGLISH

---

OPERATION MANUAL

## IMPORTANT INFORMATION

---

**WARNING:** TO REDUCE THE RISK OF FIRE OR ELECTRIC SHOCK, DO NOT EXPOSE THIS PRODUCT TO RAIN OR MOISTURE.



**CAUTION**

RISK OF ELECTRIC SHOCK.  
DO NOT OPEN.



CAUTION: TO REDUCE THE RISK OF ELECTRIC SHOCK,  
DO NOT REMOVE COVER (OR BACK).  
NO USER-SERVICEABLE PARTS INSIDE.  
REFER SERVICING TO QUALIFIED SERVICE  
PERSONNEL.



The lightning flash with arrow-head symbol, within an equilateral triangle, is intended to alert the user to the presence of uninsulated "dangerous voltage" within the product's enclosure that may be of sufficient magnitude to constitute a risk of electric shock to persons.



The exclamation point within a triangle is intended to alert the user to the presence of important operating and maintenance (servicing) instructions in the literature accompanying the product.

# IMPORTANT INFORMATION

## Declaration of Conformity

SHARP LCD AV MONITOR MODEL LC-20M4U

This device complies with part 15 of the FCC rules. Operation is subject to the following conditions: (1) This device may not cause harmful interference, and (2) this device must accept any interference received, including interference that may cause undesired operation.

Responsible Party:

SHARP ELECTRONICS CORPORATION  
Sharp Plaza, Mahwah, New Jersey 07430  
TEL : 1-800-BE-SHARP (1-800-237-4277)

U.S.A. ONLY

**WARNING:** FCC Regulations state that any unauthorized changes or modifications to this equipment not expressly approved by the manufacturer could void the user's authority to operate this equipment.

U.S.A. ONLY

**CAUTION:** Use the supplied AC cord as it is.  
Do not remove the core part from the AC cord, and do not change the way of winding cables around the core part.

## INFORMATION

This equipment has been tested and found to comply with the limits for a Class B digital device, pursuant to Part 15 of the FCC Rules. These limits are designed to provide reasonable protection against harmful interference in a residential installation. This equipment generates, uses, and can radiate radio frequency energy and, if not installed and used in accordance with instructions, may cause harmful interference to radio communications. However, there is no guarantee that interference will not occur in a particular installation. If this equipment does cause harmful interference to radio or television reception, which can be determined by turning the equipment off and on, the user is encouraged to try to correct the interference by one or more of the following measures:

- Relocate or adjust the receiving antenna.
- Increase the separation between the equipment and receiver.
- Connect the equipment into an outlet on a circuit different from that to which the receiver is connected.
- Consult the dealer or an experienced radio/TV technician for help.

U.S.A. ONLY

## IMPORTANT INFORMATION (Continued)

---

**CAUTION:** TO PREVENT ELECTRIC SHOCK, MATCH WIDE BLADE OF PLUG TO WIDE SLOT, FULLY INSERT.

This product utilizes tin-lead solder, and fluorescent lamp containing a small amount of mercury. Disposal of these materials may be regulated due to environmental considerations. For disposal or recycling information, please contact your local authorities or the Electronic Industries Alliance: [www.eia.org](http://www.eia.org)

# DEAR SHARP CUSTOMER

---

Thank you for your purchase of the Sharp LCD product. To ensure safety and many years of trouble-free operation of your product, please read the Safety Precautions carefully before using this product.

## IMPORTANT SAFETY PRECAUTIONS

---

Electricity is used to perform many useful functions, but it can also cause personal injuries and property damage if improperly handled. This product has been engineered and manufactured with the highest priority on safety. However, improper use can result in electric shock and/or fire. In order to prevent potential danger, please observe the following instructions when installing, operating and cleaning the product. To ensure your safety and prolong the service life of your LCD product, please read the following precautions carefully before using the product.

1. Read instructions—All operating instructions must be read and understood before the product is operated.
2. Keep this manual in a safe place—These safety and operating instructions must be kept in a safe place for future reference.
3. Observe warnings—All warnings on the product and in the instructions must be observed closely.
4. Follow instructions—All operating instructions must be followed.
5. Cleaning—Unplug the power cord from the AC outlet before cleaning the product. Use a damp cloth to clean the product. Do not use liquid cleaners or aerosol cleaners.
6. Attachments—Do not use attachments not recommended by the manufacturer. Use of inadequate attachments can result in accidents.
7. Water and moisture—Do not use the product near water, such as bathtub, washbasin, kitchen sink and laundry tub, swimming pool and in a wet basement.
8. Stand—Do not place the product on an unstable cart, stand, tripod or table. Placing the product on an unstable base can cause the product to fall, resulting in serious personal injuries as well as damage to the product. Use only a cart, stand, tripod, bracket or table recommended by the manufacturer or sold with the product.
9. When relocating the product placed on a cart, it must be moved with utmost care. Sudden stops, excessive force and uneven floor surface can cause the product to fall from the cart.
10. Ventilation—The vents and other openings in the cabinet are designed for ventilation. Do not cover or block these vents and openings since insufficient ventilation can cause overheating and/or shorten the life of the product. Do not place the product on a bed, sofa, rug or other similar surface, since they can block ventilation openings. This product is not designed for built-in installation; do not place the product in an enclosed place such as a bookcase or rack, unless proper ventilation is provided or the manufacturer's instructions are followed.
11. Power source—This product must operate on a power source specified on the specification label. If you are not sure of the type of power supply used in your home, consult your dealer or local power company. For units designed to operate on batteries or another power source, refer to the operating instructions.
12. Power cord protection—The power cords must be routed properly to prevent people from stepping on them or objects from resting on them. Check the cords at the plugs and product.
13. If the AC adapter is misplaced or needs to be replaced, obtain the same type of adapter from a SHARP service center or your dealer.
14. If you plan to use a 13-VDC power supply unit other than the AC adapter supplied with the product, make sure the power supply unit provides stable voltage with minimum fluctuations. Unstable power supply can cause problems in the product.
15. The LCD panel used in this product is made of glass. Therefore, it can break when the product is dropped or applied with impact. Be careful not to be injured by broken glass pieces in case the LCD panel breaks.
16. Overloading—Do not overload AC outlets or extension cords. Overloading can cause fire or electric shock.
17. Entering of objects and liquids—Never insert an object into the product through vents or openings. High voltage flows in the product, and inserting an object can cause electric shock and/or short internal parts. For the same reason, do not spill water or liquid on the product.



18. Servicing—Do not attempt to service the product yourself. Removing covers can expose you to high voltage and other dangerous conditions. Request a qualified service person to perform servicing.
19. Repair—If any of the following conditions occurs, unplug the power cord from the AC outlet, and request a qualified service person to perform repairs.
  - a. When the power cord or plug is damaged.
  - b. When a liquid was spilled on the product or when objects have fallen into the product.
  - c. When the product has been exposed to rain or water.
  - d. When the product does not operate properly as described in the operating instructions.

Do not touch the controls other than those described in the operating instructions. Improper adjustment of controls not described in the instructions can cause damage, which often requires extensive adjustment work by a qualified technician.
  - e. When the product has been dropped or damaged.
  - f. When the product displays an abnormal condition. Any noticeable abnormality in the product indicates that the product needs servicing.
20. Replacement parts—In case the product needs replacement parts, make sure that the service person uses replacement parts specified by the manufacturer, or those with the same characteristics and performance as the original parts. Use of unauthorized parts can result in fire, electric shock and/or other danger.
21. Safety checks—Upon completion of service or repair work, request the service technician to perform safety checks to ensure that the product is in proper operating condition.
22. Heat sources—Keep the product away from heat sources such as radiators, heaters, stoves and other heat-generating products (including amplifiers).
23. Polarization—This AC adapter may be equipped with a polarized alternating current line plug (a plug having one blade wider than the other). This plug will fit into the power outlet only one way. This is a safety feature. If you are unable to insert the plug fully into the outlet, try reversing the plug. If the plug should still fail to fit, contact your electrician to replace your obsolete outlet. Do not defeat the safety purpose of the polarized plug.

The LCD panel is a very high technology product with 921,600 thin film transistors, giving you fine picture details. Occasionally, a few non-active pixels may appear on the screen as a fixed point of blue, green or red. Please note that this does not affect the performance of your product.



# CONTENTS

---

	Page
DEAR SHARP CUSTOMER .....	4
IMPORTANT SAFETY PRECAUTIONS .....	4
SUPPLIED ACCESSORIES .....	7
PREPARATION .....	8
Power Connection .....	8
Batteries for Remote Control .....	8
PART NAMES (Main Unit) .....	9
Opening and Closing Front Cover .....	9
Removing Back Cover .....	10
PART NAMES (Remote Control) .....	11
BASIC OPERATION .....	12
Turning on MAIN POWER .....	12
Switching the AV INPUT [AV1/AV2] Mode .....	12
Sound Volume .....	13
ON/OFF Standby .....	13
SELECTING THE MENU ITEMS .....	14
ADJUSTMENT .....	15
Adjusting the LANGUAGE Settings .....	15
Adjusting the PICTURE Settings .....	16
Adjusting the SET UP Settings .....	18
Adjusting the SLEEP TIMER Settings .....	19
CONNECTING TO EXTERNAL DEVICES .....	20
Connecting to a VCR, a DVD player etc. (AV 1/2 IN) .....	20
Connecting to a DVD player (COMPONENT terminal) .....	21
Outputting video and audio (video output) .....	22
Listening with Headphones .....	22
Fixing the Cables .....	22
Watching TV .....	23
TROUBLESHOOTING .....	24
SPECIFICATIONS .....	25
DIMENSIONAL DRAWINGS .....	26

# SUPPLIED ACCESSORIES

Make sure the following accessories are provided with the product.

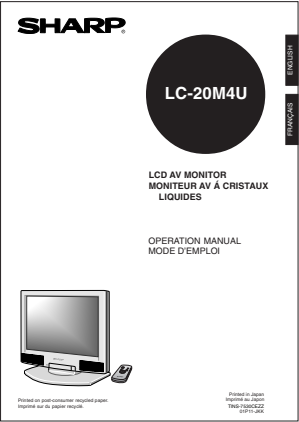
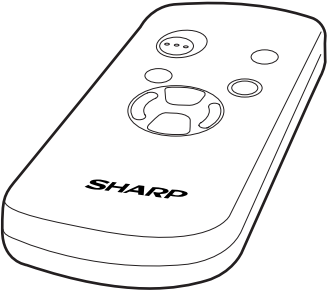
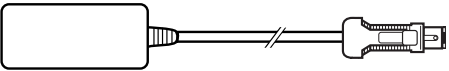
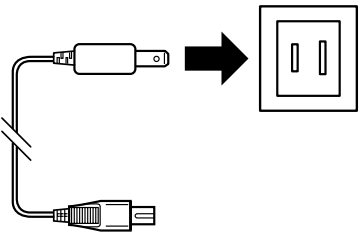
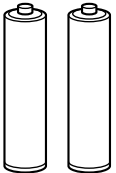
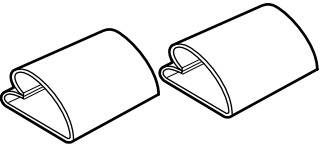
Operation Manual (×1)	Wireless Remote Control (×1)
 <p>TINS-7530CEZZ</p>	 <p>RRMCG1459CESA</p>
AC Adapter (×1)	AC Cord (×1)
 <p>UADP-0220CEZZ</p>	 <p>QACCD3088CEZZ</p> <p>* Product shape varies in some countries</p>
“AAA” size (UM/SUM-4) Dry Battery (×2)	Cable Clamp (×2)
 <p>UBATU0026GEZZ</p>	 <p>LHLDW1028GEZZ</p>





# PREPARATION

## Power Connection

Plug into AC outlet.

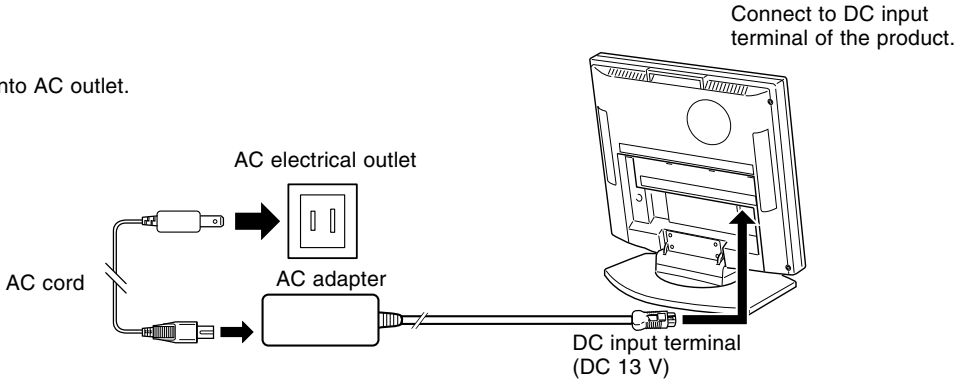

### Notes:

- Use a commercially available AC plug adapter, if necessary, depending on the design of the wall.
- Always turn the main power switch of the LCD monitor to OFF when connecting the AC adapter.
- Always unplug the AC adapter from the product and power outlet when not being used for a long period of time.

## Batteries for Remote Control

If the remote control fails to operate monitor functions, replace the batteries in the remote control.

- 1** Open the battery cover.

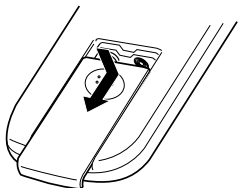

- Slide the cover while pressing down.

- 2** Insert batteries (two “AAA” size (UM/SUM-4) batteries, supplied with product).

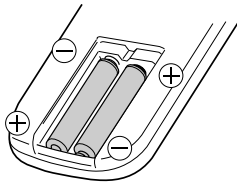

- Place batteries with their terminals corresponding to the (+) and (-) indications in the battery compartment.

- 3** Close the battery cover.

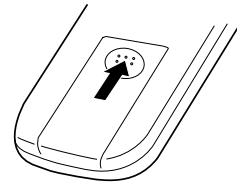

### ⚠ Caution!

#### Cautions regarding batteries

Improper use of batteries can result in a leakage of chemicals and/or explosion. Be sure to follow the instructions below.

- Place batteries with their terminals corresponding to the (+) and (-) indications.
- Different types of batteries have different characteristics. Do not mix batteries of different types.
- Do not mix old and new batteries. Mixing old and new batteries can shorten the life of new batteries and/or cause old batteries to leak chemicals.
- Remove batteries when they become weak.  
Chemicals that leak from batteries can cause a rash. If chemical leakage is found, wipe with a cloth.
- The batteries supplied with the product may have a shorter life expectancy due to storage conditions.
- If the remote control is not used for an extended period of time, remove batteries from the remote control.

# PART NAMES (Main Unit)

## Main unit (front view)

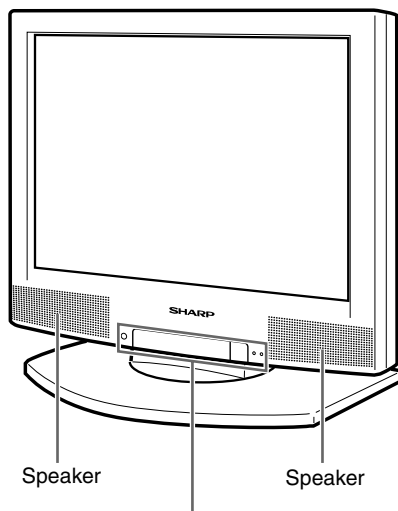

To change the vertical angle of the LCD monitor, tilt the screen up to 10 degrees backward. The monitor can also be rotated 20 degrees horizontally. Please adjust the angle so that the monitor can be watched most comfortably.

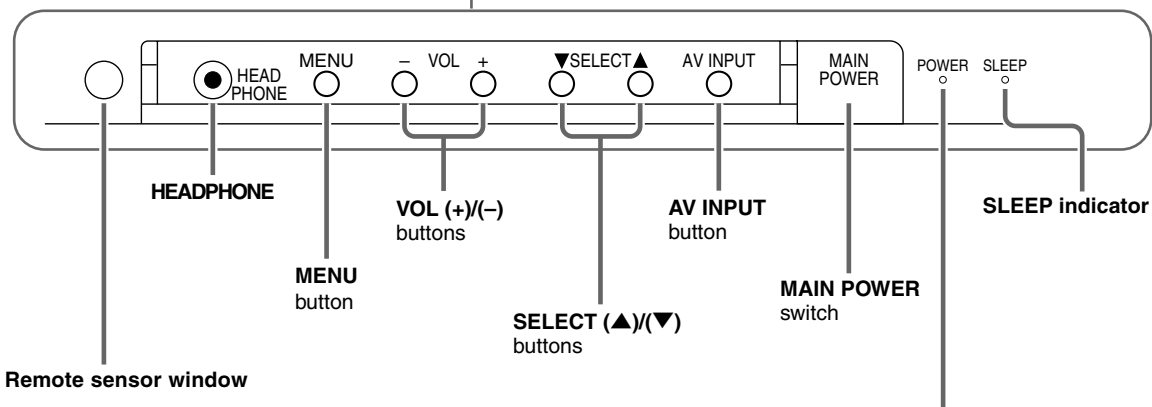

### POWER indicator

A green indicator lights when the power is on and a red indicator lights when in the standby mode (the indicator will not light when the main power is off).

### Note:

- **MENU**, **VOL (+)/(-)**, **SELECT(▲)/(▼)**, and **AV INPUT** on the main unit have the same functions as the same buttons on the remote control. Fundamentally, this operation manual provides a description based on operation using the remote control.

## Opening and Closing Front Cover

- To open the cover, push .
- To close the cover, press the upper part of the cover.

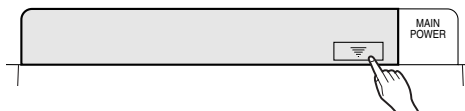

# PART NAMES (Main Unit) (Continued)

## Main unit (rear view)

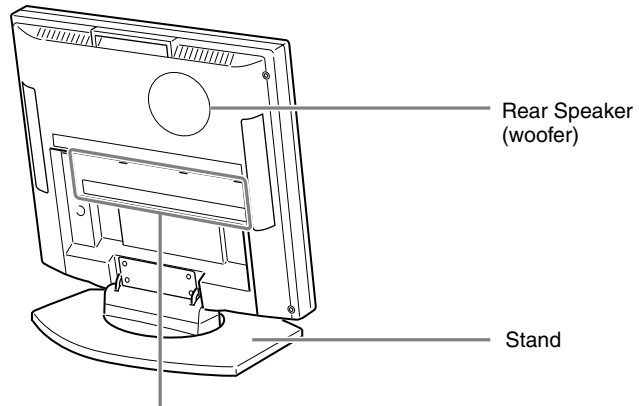

## Rear terminal section

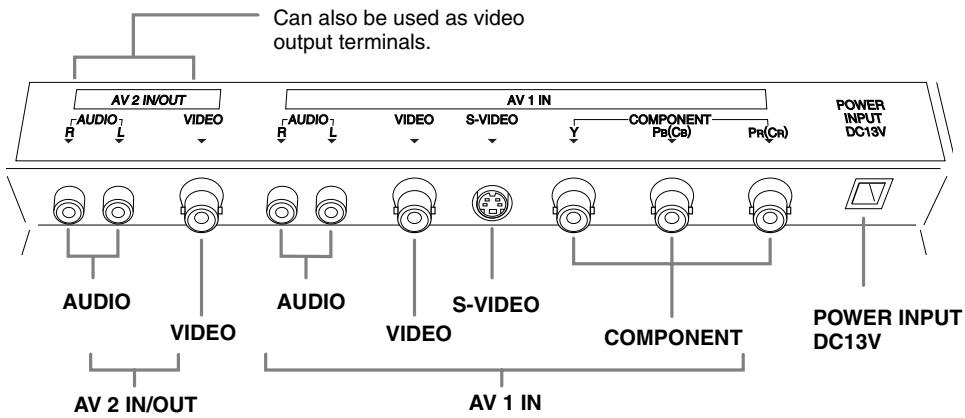

## Removing Back Cover

■ When connecting the cords to the terminals, remove the back cover by gently pulling the part marked ○ forward.

■ To replace the back cover, first fit the four top clips (①) into the corresponding slots of the terminal section, and then align the four side clips (②) with the corresponding slots. Then, press the marked parts (③) until the two hooks on the bottom of the cover lock in place with a click.

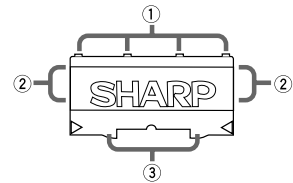

### Caution!

Before using the LCD AV monitor, be sure to remove the protection tape and sheet from the back cover.

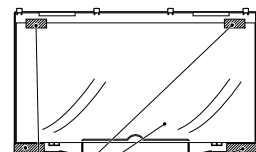

protection tape and sheet

# PART NAMES (Remote Control)

## Remote control

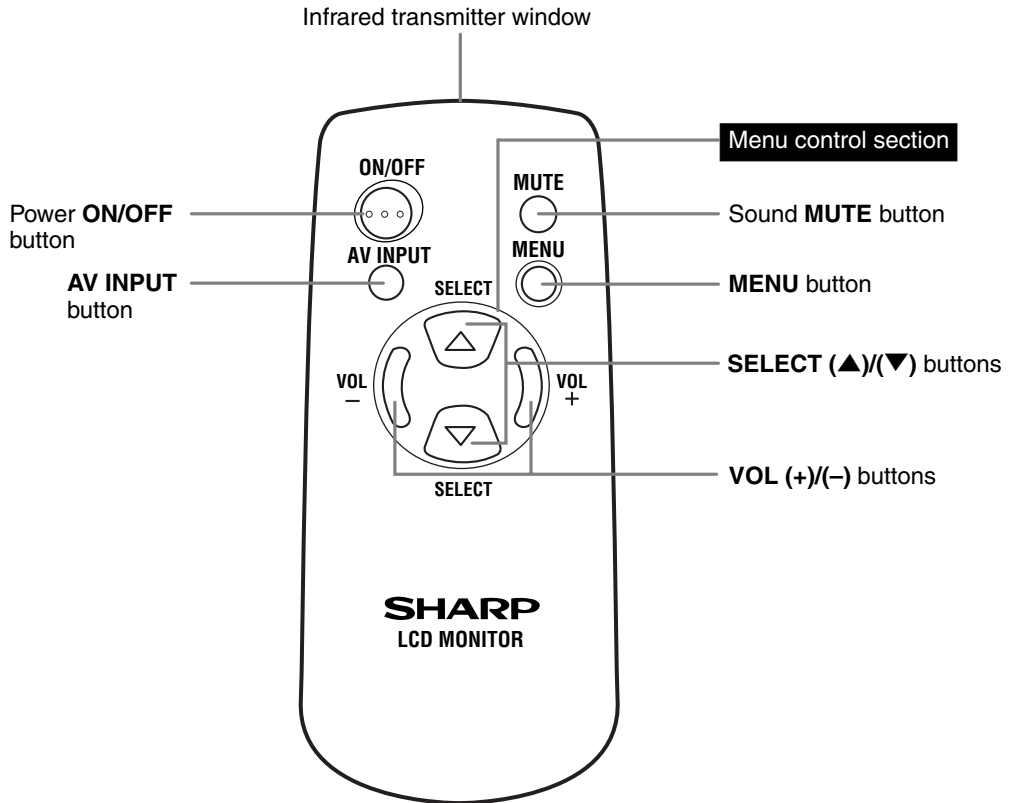

### Note:

- **MENU**, **VOL (+)/(-)**, **SELECT(▲)/(▼)**, and **AV INPUT** on the main unit have the same functions as the same buttons on the remote control. Fundamentally, this operation manual provides a description based on operation using the remote control.

# BASIC OPERATION

## Turning on MAIN POWER

### Control section of main unit

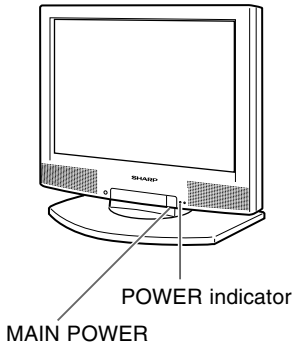

- 1 Press **MAIN POWER**, located on the front side of the main unit.
- 2 The **POWER indicator** instantaneously changes from red to green and the main unit is turned on.

#### Notes:

- When the **POWER indicator** is red, press **ON/OFF** on the remote control to turn on the monitor. The **POWER indicator** changes from red to green.
- The input mode indication disappears after five seconds.

#### ▼ On-screen display

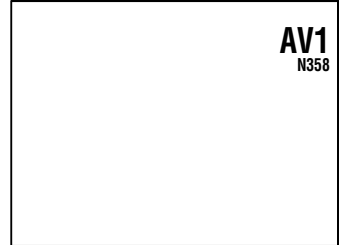

## Switching the AV INPUT [AV1/AV2] Mode

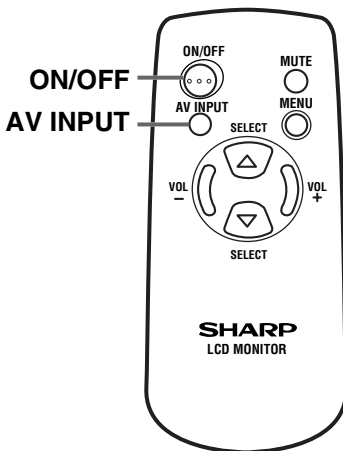

- 1 Turn on the power of the connected video equipment.
- 2 Press **AV INPUT** and select the applicable input source. The screen displays **AV1** or **AV2** mode at the upper right corner each time **AV INPUT** is pressed.

#### Note:

- The AV input mode indication remains for five seconds.
- **AV1**: Select **AV1** when video equipment is connected to the AV 1 IN terminals. The display of the **AV1** mode indicates either **AV1** or **COMPONENT** depending on the adjustment of the **SET UP** settings. **AV1** is displayed when **AV1** is set to **NORMAL** in the **SET UP** settings, and **COMPONENT** is displayed when **AV1** is set to **COMPONENT**. (see page 18)
- **AV2**: The **AV2** mode can be set to either **IN** or **OUT** in the **SET UP** settings. (see page 18) **AV2** indication is not displayed when the mode is selected to **OUT**.

#### Initial mode (AV1)

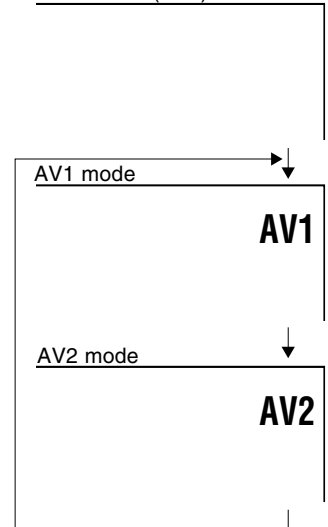

## Sound Volume

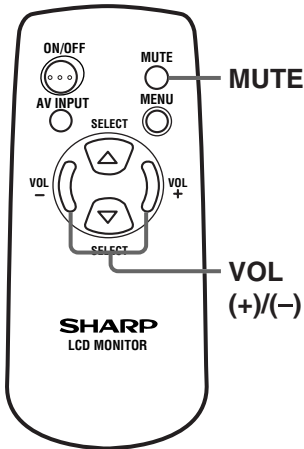

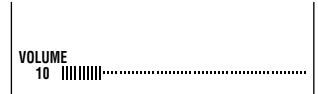

### To adjust the volume

- Press **VOL (+)** to increase the sound volume. The indicator segment increases.
- Press **VOL (-)** to decrease the sound volume. The indicator segment decreases.



### To mute the sound

- Press **MUTE** to temporarily turn off the sound. The MUTE mark  is displayed.
- Press **MUTE** or **VOL (+)/(-)** to turn the sound back to the previous level. The MUTE mark  disappears.

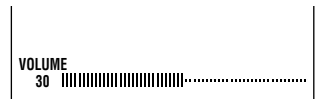

**Note:**

- MUTE is automatically cleared when the following button is pressed: **ON/OFF**, **VOL (+)/(-)** or **MUTE**.

## ON/OFF Standby

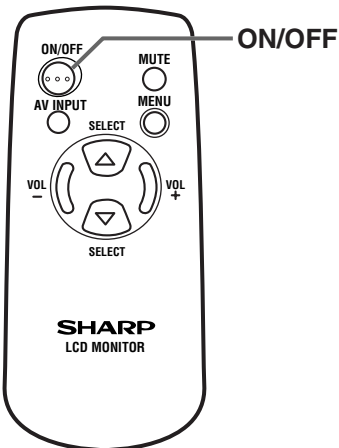

### To turn off the LCD monitor

Press **ON/OFF**.  
The POWER indicator turns red.

### To turn the LCD monitor back on

Press **ON/OFF** again.  
The POWER indicator turns green.

# SELECTING THE MENU ITEMS

## Selecting the Menu Items

- This LCD monitor set allows you to adjust the picture, sound, and other features using the On-screen Display. Select the desired menu item by following the steps below and then refer to the indicated page for details.

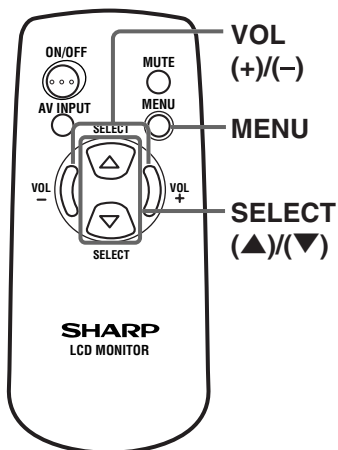

**1** Press **MENU** to display the MENU screen.

**2** Press **SELECT (▲)/(▼)** to select the desired menu item.

- The cursor moves up or down.
- The cursor indicates the selected menu item.

**3** Press **VOL (+)/(-)** to enter.

**4** Press **MENU** again to exit.

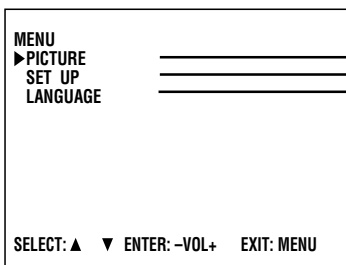

(Pages 16 and 17)

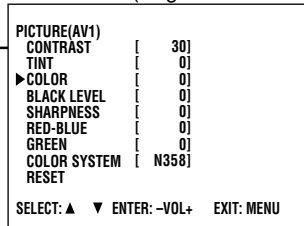

(Pages 18 and 19)

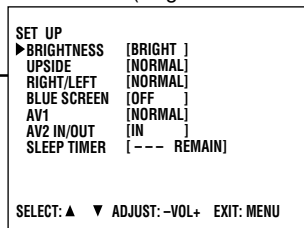

(Page 15)

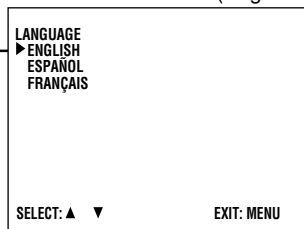

### Notes:

- The displayed items differ depending on the setting conditions.
- The selected item is highlighted in yellow.
- Items in purple cannot be selected.
- The original screen is restored by pressing **MENU** on the menu screen or any of the adjustment screens. The original screen is also restored when no buttons have been pressed for about a period of 30 seconds. The adjustment values and settings that were changed before the screen is restored are saved as is in the memory.

\* The screen indications shown above are larger than actual size for easy reading.

# ADJUSTMENT

## Adjusting the LANGUAGE Settings

**MENU** on the LCD monitor set can also be used to select the language.

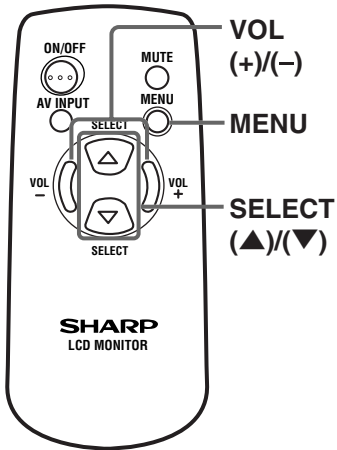

- 1 Press **MENU** to display the MENU screen.
- 2 Press **SELECT (▲)/(▼)** to move the cursor to LANGUAGE, and then press **VOL (+)/(-)** to display the LANGUAGE screen.
- 3 Press **SELECT (▲)/(▼)** to select the language you want to display.
- 4 Press **MENU** again to exit.

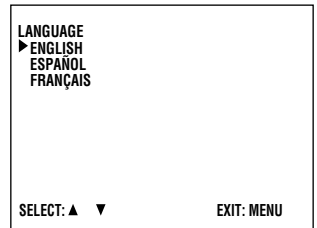
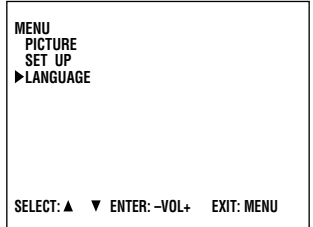



# ADJUSTMENT (Continued)



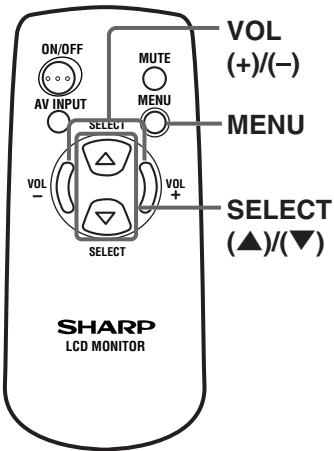

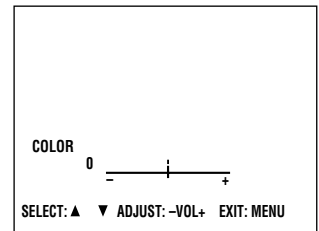
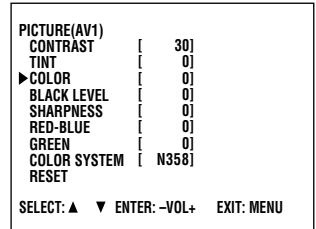
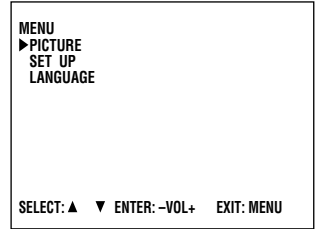

## Adjusting the PICTURE Settings



- 1 Press **MENU** to display the MENU screen.
- 2 Press **SELECT (▲)/(▼)** to move the cursor to PICTURE, and then press **VOL (+)/(-)** to display the PICTURE screen.
- 3 Press **SELECT (▲)/(▼)** to move the cursor and select the desired adjustment item.  
All items that can be adjusted are shown in the table on the next page.
- 4 Press **VOL (+)/(-)** to display the screen for the selected adjustment item.
- 5 Press **VOL (+)/(-)** to make the adjustment.
- 6 Press **MENU** again to exit.

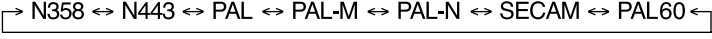

## Adjusting the PICTURE Settings (Continued)

Selected item	Press <b>VOL (-)</b> .	Press <b>VOL (+)</b> .
CONTRAST	Decrease contrast 	Increase contrast
TINT	Toward purple 	Toward green
COLOR	Lower color intensity 	Higher color intensity
BLACK LEVEL	Decrease brightness 	Increase brightness
SHARPNESS	Soft picture 	Sharp picture
RED-BLUE	More red 	More blue
GREEN	Less green 	More green
COLOR SYSTEM	Press <b>VOL (+)/(-)</b> to select COLOR SYSTEM. 	

**Note:**

■ TINT is displayed only when N358 or N443 is selected.

### Switching the COLOR SYSTEM

Set the system to N358 for normal reception.

When the picture is not stable, switching to an appropriate system may improve the picture quality.

# ADJUSTMENT (Continued)



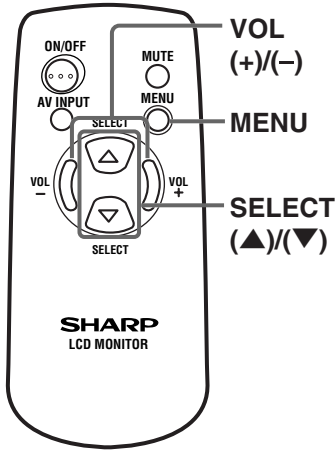

## Adjusting the SET UP Settings

The SET UP items can be set by the user.

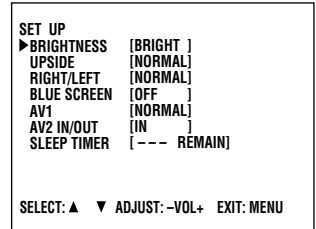
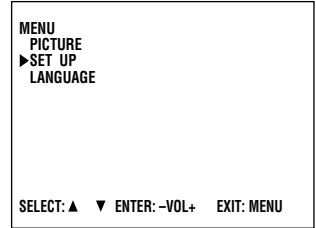

- 1 Press **MENU** to display the MENU screen.
- 2 Press **SELECT (▲)/(▼)** to move the cursor to SET UP.
- 3 Press **VOL (+)/(-)** to display the SET UP screen.
- 4 Check the factory setting of each item on the SET UP screen. The user can change the settings with **SELECT (▲)/(▼)** and **VOL (+)/(-)**.
- 5 Press **MENU** again to exit.



Selected item	Factory setting	Setting change
BRIGHTNESS	[BRIGHT] Maximum brightness	[NORMAL] Brightness 60% → Suitable for viewing in well-lit areas. Saves energy. [DARK] Brightness 20% → Sufficiently bright when viewing in dim areas.
UPSIDE	[NORMAL] Normal vertical image orientation	[DOWN] Inverted image → To display images upside down for special applications. 
RIGHT/LEFT	[NORMAL] Normal horizontal image orientation	[MIRROR] Mirror image → To display mirror images for special applications. 
BLUE SCREEN	[OFF] This feature is inactive.	[ON] The screen is turned blue when there is no signal.
AV1	[NORMAL]	[COMPONENT]
AV2 IN/OUT	[IN]	[OUT  [OUT 
SLEEP TIMER	[ --- REMAIN]	The setting can be specified in increments of 30 minutes and in a range between 30 and 120 minutes. (see page 19)

**Note:**

■ In BLUE SCREEN, PICTURE setting displayed in purple cannot be selected.

## Adjusting the SLEEP TIMER Settings

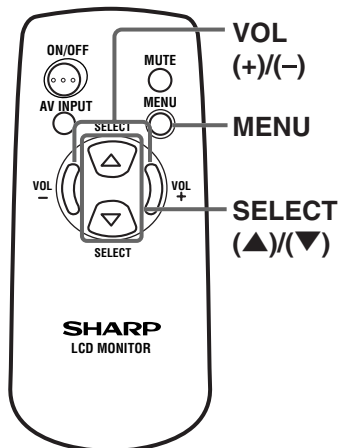

- 1 Press **MENU** to display the MENU screen.
- 2 Press **SELECT (▲)/(▼)** to move the cursor to SET UP, and then press **VOL (+)/(-)** to display the SET UP screen.

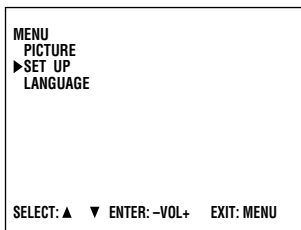

- 3 Press **SELECT (▲)/(▼)** to move the cursor to SLEEP TIMER, and then press **VOL (+)/(-)** to set SLEEP TIMER (in minutes).  
The setting can be specified in increments of 30 minutes and in a range between 30 and 120 minutes. The setting is turned off when --- is displayed.

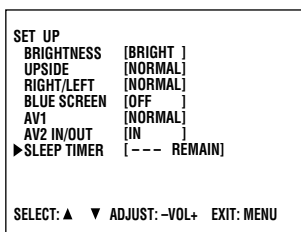

- 4 Press **MENU** again to exit.

### Note:

- If the monitor's power is turned off and then turned back on again after the SLEEP TIMER has been set, the setting will be canceled.



# CONNECTING TO EXTERNAL DEVICES

## Connecting to a VCR, a DVD Player, etc. (AV 1/2 IN)

This LCD monitor can be connected to most external devices as shown below.

When connecting to an external device, turn off the power of the main unit and then connect to the device to prevent any possible damage.

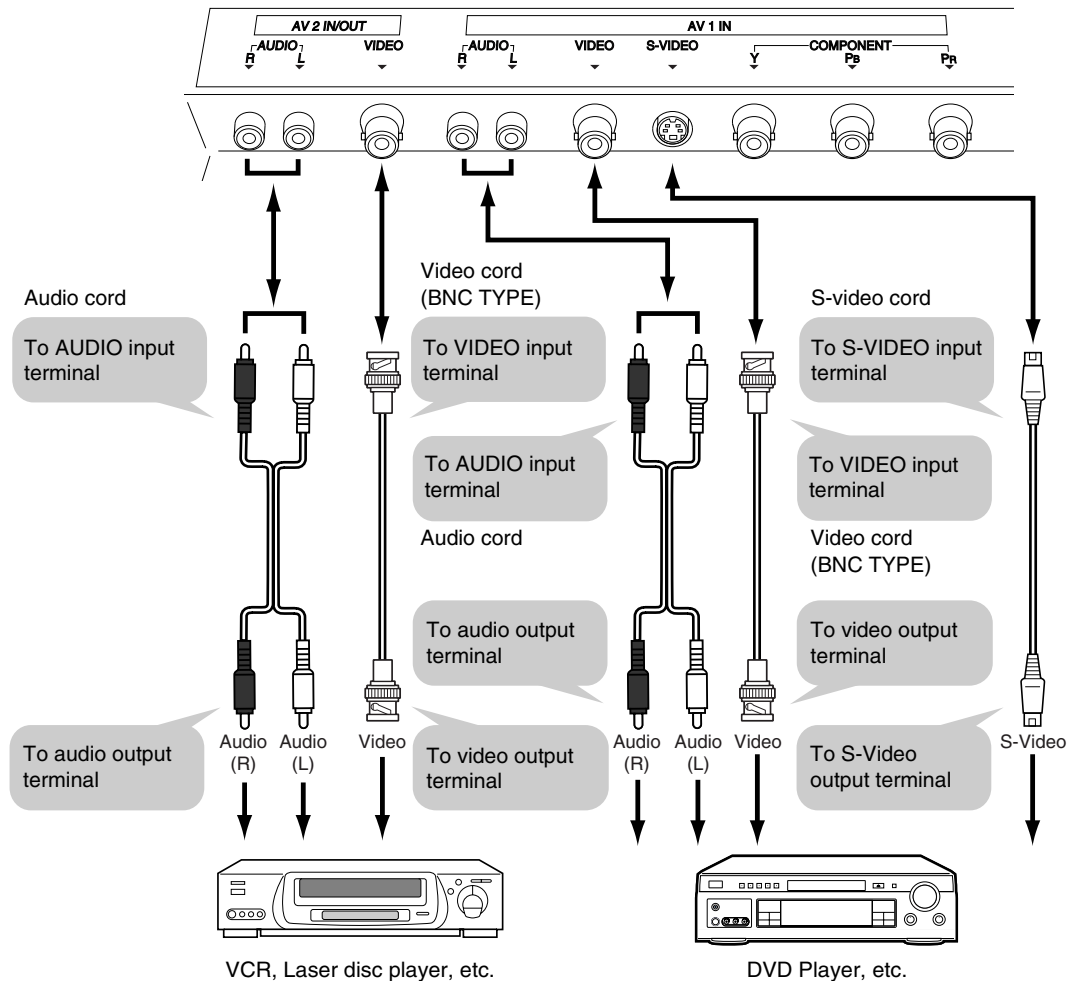

\* For improved picture quality from video sources with COMPONENT output, use the connection diagram on page 21.

### Notes:

- PC connection is not possible.
- Use a commercially available audio/video cord for the cable.
- When connecting or disconnecting the video cord (BNC TYPE) to or from the VIDEO input terminal, disconnect the audio cable.
- Only connect audio/video signals to AV 1/2 IN terminals. Connecting other signals may result in a malfunction.
- When external devices are connected to both the VIDEO and S-VIDEO terminals (and AV1 is selected), priority is given to the S-VIDEO input terminal. To view images from the VIDEO input terminal, do not connect any cable to the S-VIDEO terminal.
- For details concerning the usage and connection of external devices, see their respective instruction manuals.

# CONNECTING TO EXTERNAL DEVICES (Continued)

## Connecting to a DVD player (COMPONENT terminal)

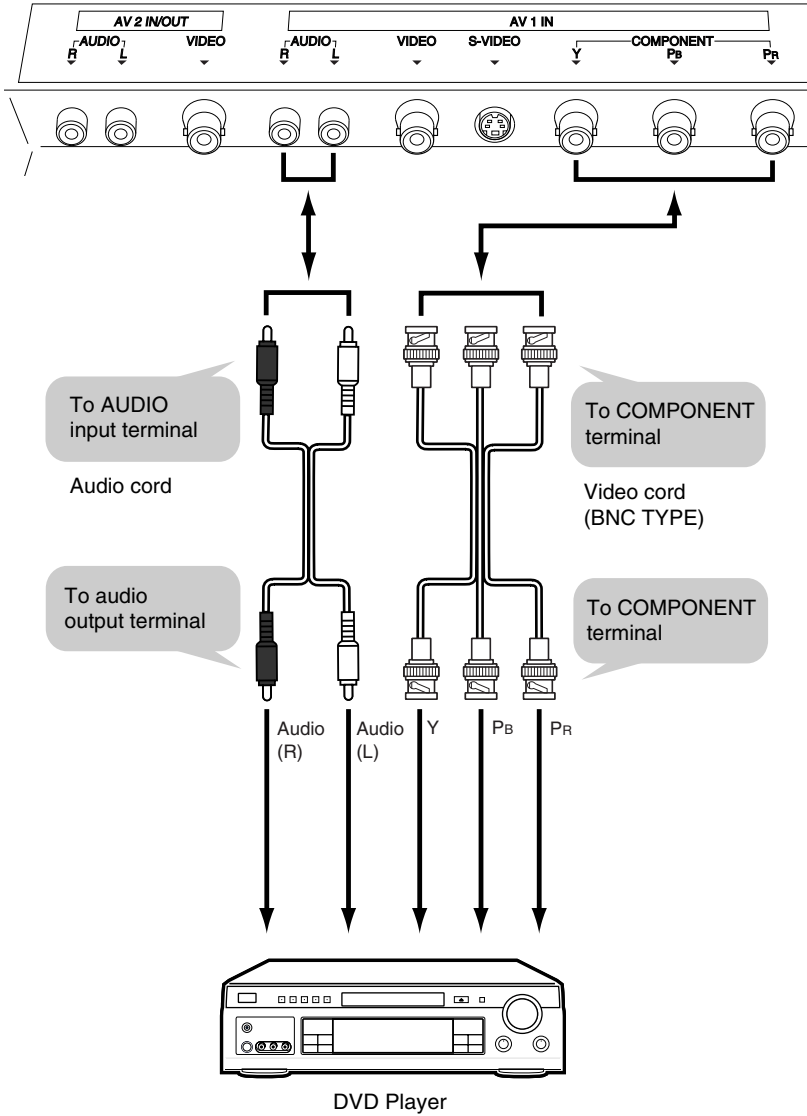

### Note:

- To view the image from the component connected to the terminals for AV 1 IN, set AV1 to COMPONENT with the SET UP setting (see page 18).

# CONNECTING TO EXTERNAL DEVICES (Continued)

## Outputting video and audio (video output)

It is possible to output video and audio from the set through the AV output terminals (AV 2 IN/OUT).

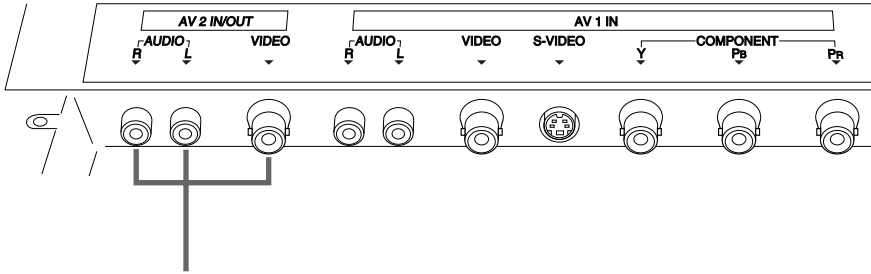

Connect a VCR, Audio amplifiers, etc

### Notes:

- AV2 can be set to input or output. When set to input, output is not possible and vice versa.
- When using COMPONENT and/or S-VIDEO terminal, it is not possible to output video, but it is possible to output audio for connecting to audio systems.

## Listening with Headphones

- Plug the headphone mini-plug into the headphone jack located on the front side of the set.

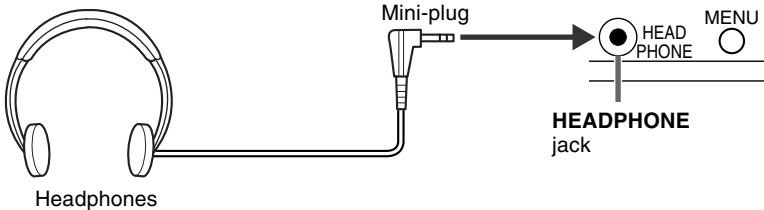

### ▼ On-screen display

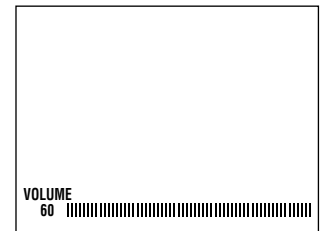

### Notes:

- The headphones are not included in the supplied accessories.
- No sound will be heard from the main unit speakers when the headphones are connected.

## Fixing the Cables

- Secure cables and cords with the supplied cable clamps so that they do not get caught when mounting the cover.
- Connect the cables and cords after affixing the cable clamps (2 positions) close to the AUDIO input terminal and the POWER INPUT terminal.

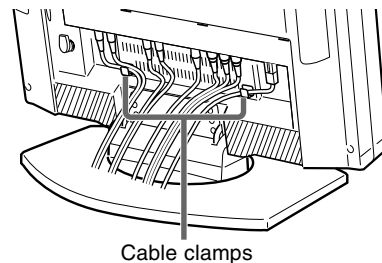

# CONNECTING TO EXTERNAL DEVICES (Continued)



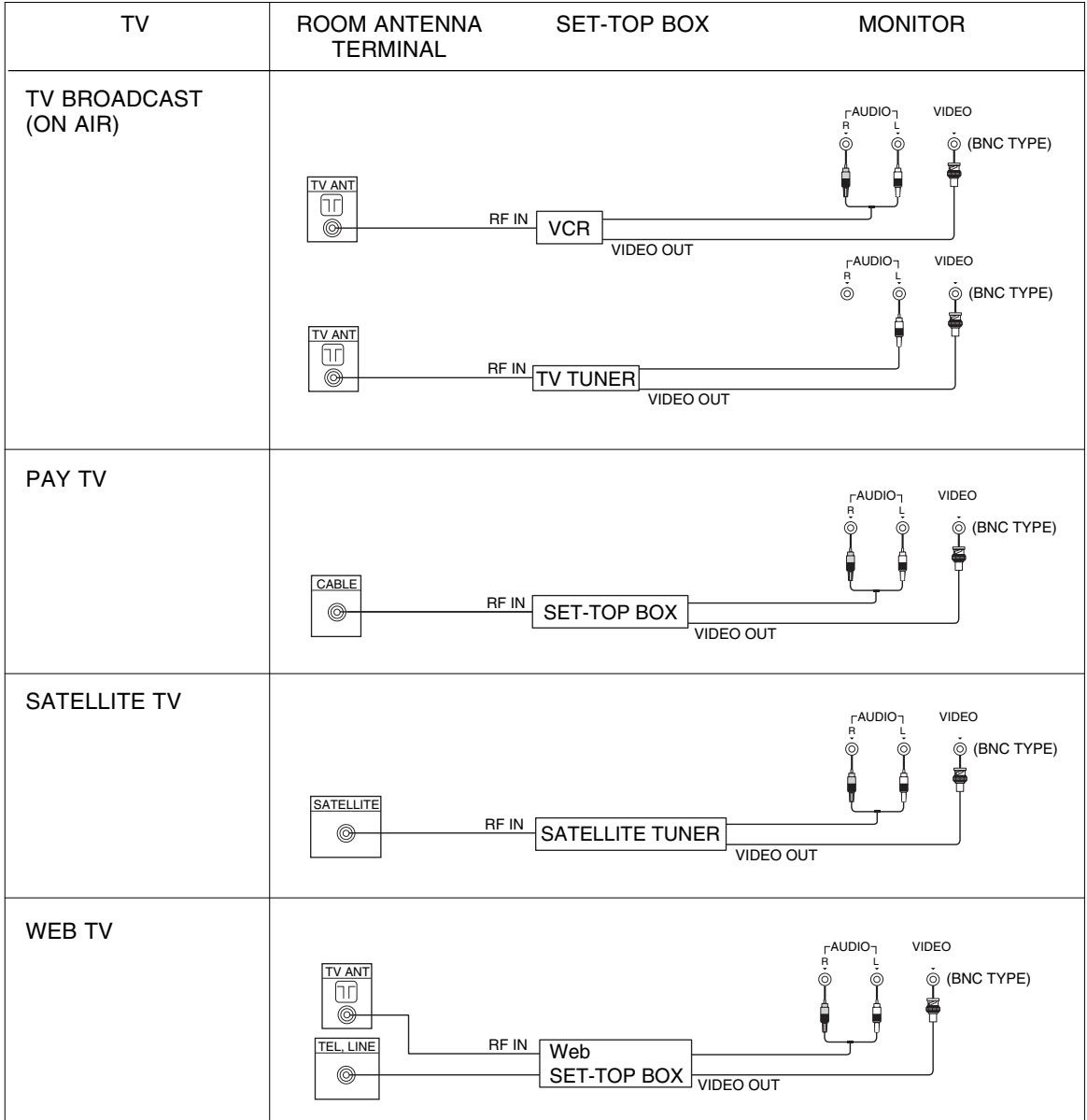

## Watching TV

To view a TV broadcast on the LCD monitor, the set-top box must be used with a TV tuner, satellite tuner or VCR. Refer to the diagram below for wiring.



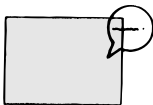

# TROUBLESHOOTING

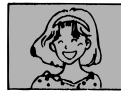
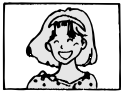
Problem	Check item	Pages
 <p>No image on screen, and no sound from speakers.</p>	<ul style="list-style-type: none"> <li>• Make sure that the AC power cord plug is securely inserted in AC power outlet and AC adapter.</li> <li>• Make sure that the AC adapter's DC output is securely connected to main unit's DC input terminal.</li> <li>• Make sure that the main power switch of the main unit is on.</li> <li>• Make sure that the AV input is properly set.</li> <li>• Make sure that the cables are correctly connected to rear terminal section of LCD monitor.</li> <li>• Check to see if the batteries in the remote control have sufficient power.</li> <li>• Make sure that the unit is not in the standby mode (power indicator is red).</li> </ul>	<p>8 12 12 8 13</p>
 <p>Speakers produce sound, but no image on screen.</p>	<ul style="list-style-type: none"> <li>• Make sure that the cables are correctly connected.</li> <li>• Make sure that AV1 is set to COMPONENT to view the image from component sources.</li> </ul>	<p>20, 21 18</p>
 <p>Image is too light or improperly tinted.</p>	<ul style="list-style-type: none"> <li>• Check COLOR and TINT adjustments. (NTSC ONLY)</li> <li>• Check CONTRAST and BLACK LEVEL adjustments.</li> <li>• Check RED-BLUE adjustments.</li> <li>• Make sure that the DVD connection cord is correctly connected to the COMPONENT terminal.</li> </ul>	<p>17 17</p>
 <p>Image is displayed, but no sound from speakers.</p>	<ul style="list-style-type: none"> <li>• Make sure that the cables are properly connected to rear terminal section of LCD monitor.</li> <li>• Check the volume adjustment.</li> <li>• Make sure that the sound is not muted.</li> <li>• Make sure that the headphones are not connected.</li> </ul>	<p>13 13 22</p>
 <p>Image is too dark.</p>	<ul style="list-style-type: none"> <li>• Check to see if BRIGHTNESS is set to DARK.</li> <li>• Check CONTRAST and BLACK LEVEL adjustments.</li> <li>• Lamp may have reached the end of its life. (Contact an authorized Sharp service facility for replacement lamp(s).)</li> </ul>	<p>18 17</p>
 <p>No colors on image.</p>	<ul style="list-style-type: none"> <li>• Check COLOR adjustment.</li> <li>• Check the color system setting.</li> <li>• Make sure that the DVD connection cord is correctly connected to P<sub>B</sub> and P<sub>R</sub> of the COMPONENT terminal.</li> </ul>	<p>17 17</p>
<p>Remote control does not work.</p>	<ul style="list-style-type: none"> <li>• Check to see if the batteries in the remote control have sufficient power.</li> <li>• Make sure that (+) and (-) side of batteries are properly positioned in remote control.</li> <li>• Make sure that the remote sensor window is not under strong fluorescent lighting.</li> </ul>	<p>8 8</p>



# SPECIFICATIONS

ITEMS		LC-20M4U	
LCD	Panel	20" Black TFT LCD	
	Number of dots	921,600 (640 × 3 × 480) dots	
	Low reflection	Non-glare	
	Brightness	430 cd/m <sup>2</sup>	
	Viewing angles	Left to right	160°
		Upper to lower	160°
	Lamp Life	40,000 hours (at normal mode)	
COLOR SYSTEM	System	N358/N443/PAL/PAL-M/PAL-N/PAL-60/SECAM	
AUDIO	Output	4.0 W (0.7 W × 2 + 2.6 W)	
	Speaker	Full range	1.2 × 1.6 in. (3 × 4 cm) Oval, 2 pcs.
		Woofers	3.1 in. (8 cm) Round, 1 pc.
TERMINALS	AV 1 IN	Video Composite (BNC TYPE), S-Video, Audio R/L	
		Component input, Y/P <sub>B</sub> /P <sub>R</sub> (BNC TYPE)	
	AV 2 IN/OUT	Video Composite (BNC TYPE), Audio R/L	
	Headphone jack	0.1 in. (3.5 mm) ø jack	
POWER SUPPLY	DC operation	DC 13 V, Typical: 3.0 A, Max: 3.8 A	
	AC operation	AC 110~240 V, 50/60 Hz with AC adapter	
	Power consumption	AC 120 V, Typical: 50 W, Standby: 0.5 W	
APPEARANCE	Exterior color	Silver	
	Outside dimensions	18.1 (W) × 17.2 (H) × 7.3 (D) in. (460 (W) × 437.5 (H) × 186 (D) mm)	
	Net weight	19.0 lbs (8.6 kg), incl. stand, excl. accessories 13.4 lbs (6.1 kg), excl. stand	
ACCESSORIES	Operation manual	Language: English/French/Spanish/Portuguese	
	Remote control	Infrared wireless type (Infrared carrier frequency: 38 kHz)	
	AC adapter	Multi-Voltage type, 1 pc. DC cable: 6.5 ft (2 m) DC power converter: 2.6 (W) × 1.5 (H) × 5.5 (D) in. (67 (W) × 37 (H) × 140 (D) mm)	
	AC cord	6.1 ft (1.85 m), 1 pc.	
	Batteries	"AAA" size (UM/SUM-4) Dry Battery × 2 pcs.	
	Cable clamp	2 pcs.	
	OSD LANGUAGE	Language	English/French/Spanish

As a part of policy of continuous improvement, SHARP reserves the right to make design and specification changes for product improvement without prior notice. The performance specification figures indicated are nominal values of production units. There may be some deviations from these values in individual units.

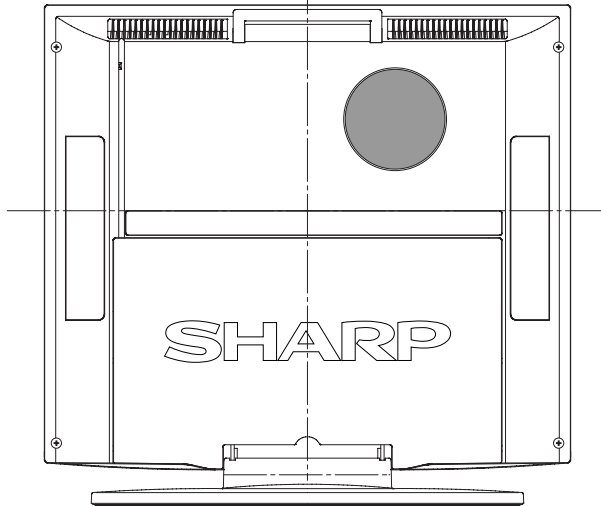
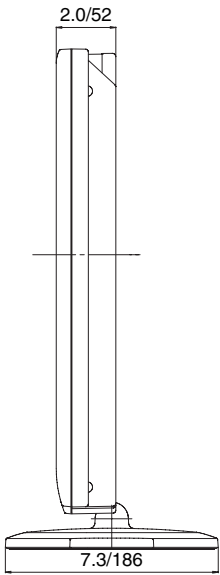
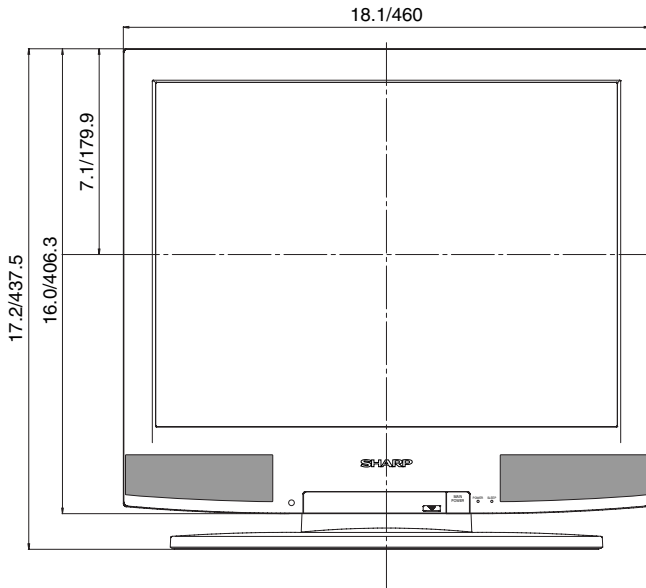

## Calling for Service

For location of the nearest Sharp Authorized Service, or to obtain product literature, accessories, supplies, or customer assistance, please call 1-800-BE-SHARP.

## LIMITED WARRANTY

### END-USER LIMITED WARRANTY

SHARP ELECTRONICS CORPORATION warrants to the first end user purchaser that this Sharp brand product (the "Product"), when shipped in its original container, will be free from defective workmanship and materials, and agrees that it will, at its option, either repair the defect or replace the defective Product or part thereof with a new or remanufactured equivalent at no charge to the purchaser for parts or labor for the period(s) set forth below.

This warranty does not apply to any appearance items of the Product nor to the additional excluded item(s) set forth below nor to any Product the exterior of which has been damaged or defaced, which has been subjected to improper voltage or other misuse, abnormal service or handling, or which has been altered or modified in design or construction.

In order to enforce the rights under this limited warranty, the purchaser should follow the steps set forth below and provide proof of purchase to the servicer.

To the extent permitted by applicable state law, the warranties set forth herein are in lieu of, and exclusive of, all other warranties, express or implied. Specifically, ALL OTHER WARRANTIES OTHER THAN THOSE SET FORTH ABOVE ARE EXCLUDED. ALL EXPRESS AND IMPLIED WARRANTIES INCLUDING THE WARRANTIES OF MERCHANTABILITY, FITNESS FOR USE, AND FITNESS FOR A PARTICULAR PURPOSE ARE SPECIFICALLY EXCLUDED. If, under applicable state law, implied warranties may not validly be disclaimed or excluded, the duration of such implied warranties is limited to the period(s) from the date of purchase set forth below.

Neither the sales personnel of the seller nor any other person is authorized to make any warranties other than those described herein, or to extend the duration of any warranties beyond the time period described herein on behalf of Sharp.

The warranties described herein shall be the sole and exclusive warranties granted by Sharp and shall be the sole and exclusive remedy available to the purchaser. Correction of defects, in the manner and for the period of time described herein, shall constitute complete fulfillment of all liabilities and responsibilities of Sharp to the purchaser with respect to the Product, and shall constitute full satisfaction of all claims, whether based on contract, negligence, strict liability or otherwise. In no event shall Sharp be liable, or in any way responsible, for any damages or defects in the Product which were caused by repairs or attempted repairs performed by anyone other than an authorized servicer. Nor shall Sharp be liable or in any way responsible for any incidental or consequential economic or property damage. Some states do not allow limits on warranties or on remedies for breach in certain transactions; in such states, the limits herein may not apply.

### Model Specific Section

**Your Product Model Number & Description:** LC-20M4U LCD AV MONITOR  
(Be sure to have this information available when you need service for your Product.)

**Warranty Period for this Product:** One (1) year parts and labor from the date of purchase.

**Additional Item(s) Excluded from Warranty Coverage (if any):** None

**Where to Obtain Service:** From a Sharp Authorized Servicer located in the United States. To find the location of the nearest Sharp Authorized Servicer, call Sharp toll free at 1-800-BE-SHARP.

**What to do to Obtain Service:** Ship prepaid or carry in your Product to a Sharp Authorized Servicer. Be sure to have **Proof of Purchase** available. If you ship the Product, be sure it is insured and packaged securely.

TO OBTAIN PRODUCT INFORMATION, CALL 1-888-LCD-SHARP.

# SHARP®

## SHARP ELECTRONICS CORPORATION

Sharp Plaza, Mahwah, New Jersey 07430-2135

## SHARP CORPORATION

OSAKA, JAPAN

# SHARP®

## LIMITED WARRANTY

### Information Systems Products

## Congratulations on your purchase!

Sharp Electronics of Canada Ltd. (hereinafter called "Sharp") gives the following express warranty to the first consumer purchaser for this Sharp brand product, when shipped in its original container and sold or distributed in Canada by Sharp or by an Authorized Sharp Dealer:

Sharp warrants that this product is free, under normal use and maintenance, from any defects in material and workmanship. If any such defects should be found in this product within the applicable warranty period, Sharp shall, at its option, repair or replace the product as specified herein.

This warranty shall not apply to:

- (a) Any defects caused or repairs required as a result of abusive operation, negligence, accident, improper installation or inappropriate use as outlined in the owner's manual.
- (b) Any Sharp product tampered with, modified, adjusted or repaired by any party other than Sharp, Sharp's Authorized Service Centres or Sharp's Authorized Servicing Dealers.
- (c) Damage caused or repairs required as a result of the use with items not specified or approved by Sharp, including but not limited to software, toner, paper and batteries.
- (d) Any replacement of accessories, glassware, consumable or peripheral items required through normal use of the product including but not limited to AC adapters, ribbon, correction tape, printwheel, ink rollers, toner, developer, drum, cables, paper, filters, software.
- (e) Any cosmetic damage to the surface or exterior that has been defaced or caused by normal wear and tear.
- (f) Any damage caused by external or environmental conditions, including but not limited to transmission line/power line voltage or liquid spillage.
- (g) Any product received without appropriate model, serial number and CSA/cUL markings.
- (h) Any products used for rental purposes.
- (i) Any installation, setup and/or programming charges.

Should this Sharp product fail to operate during the warranty period, warranty service may be obtained upon delivery of the Sharp product together with proof of purchase and a copy of this LIMITED WARRANTY statement to an Authorized Sharp Service Centre or an Authorized Sharp Servicing Dealer.

This warranty constitutes the entire express warranty granted by Sharp and no other dealer, service centre or their agent or employee is authorized to extend, enlarge or transfer this warranty on behalf of Sharp. To the extent the law permits, Sharp disclaims any and all liability for direct or indirect damages or losses or for any incidental, special or consequential damages or loss of profits resulting from a defect in material or workmanship relating to the product, including damages for the loss of time or use of this Sharp product or the loss of information. The purchaser will be responsible for any removal, reinstallation, transportation and insurance costs incurred. Correction of defects, in the manner and period of time described herein, constitute complete fulfillment of all obligations and responsibilities of Sharp to the purchaser with respect to the product and shall constitute full satisfaction of all claims, whether based on contract, negligence, strict liability or otherwise.

#### WARRANTY PERIODS

Personal Copier	3 years
Personal Facsimile	1 year
High End Personal Computer	3 years (rechargeable battery 1 year)
LCD Projectors (XG & PG Series)	3 years (bulb 90 days)
LCD Monitor	1 year
Laser Printer	1 year
Inkjet Printer	1 year
Open Line Electronic Cash Register	6 months

To obtain the name and address of the nearest Authorized Sharp Service Centre or Dealer, please contact:  
SHARP ELECTRONICS OF CANADA LTD.

SHARP ELECTRONICS OF CANADA LTD  
335 Britannia Road East  
Mississauga, Ontario  
L4Z 1W9  
(905) 568-7140 or 1 (877) SHARP-CC  
Website: [www.sharp.ca](http://www.sharp.ca)



VALID IN CANADA ONLY